

#5763
1941

PARKER SALES CONTINUE TO CLIMB.

*Second Semester
Advertising Campaign gives
Extra Zoom to 1941 Demand
for World's Finest Pen*

World wide Reports Show AMAZING INCREASE IN PARKER SALES...

despite war and unsettled conditions

That Parker Pen is no "fairweather" favorite is shown by sales reports for 1940 and the first months of 1941. During these days of uncertainty in trade, Parker dealers throughout the world reported an **increased demand** for Parker pens, pencils and gift sets. The reason? . . . The public knows that Parker is not a mere luxury item that can be dispensed with during present economies — but that every Parker product stands for quality, durability and lasting service.

Through powerful and consistent advertising — through the enthusiastic recommendation of friends — through the reputation of Parker dealers — your customers have full confidence in the **VALUE** of a Parker guarantee.

PARKER'S BLUE  DIAMOND IS A
GUARANTEED LIFE CONTRACT

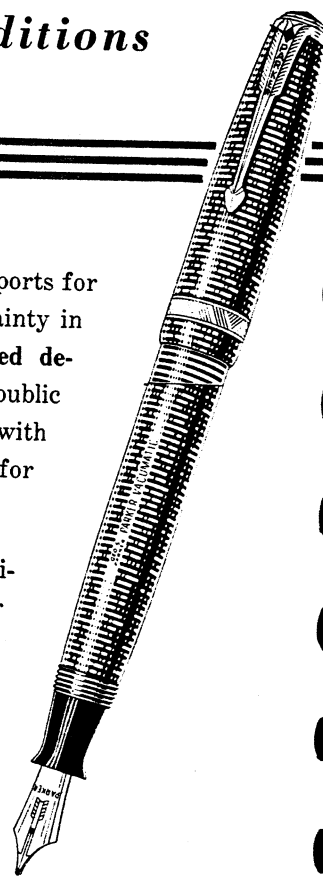

NEW LIFE CONTRACT GUARANTEE

Parker's Blue Diamond on the Pen is our Life Contract with the owner, Guaranteeing to make good any mishap (except loss or intentional damage) subject only to a small service charge to cover postage, insurance, and handling, provided complete pen is returned for service.

W
E
..
LS
EE
teeing to
ll service
or service.

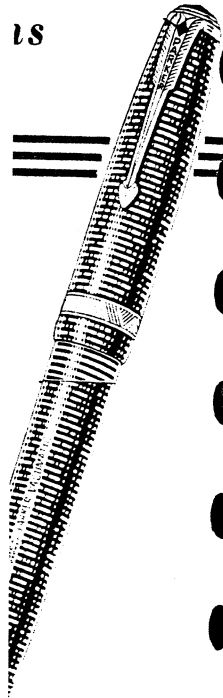

EXTRA
VALUE
to Your
CUSTOMERS

NEWS *of the Day*

EXTRA
PROFITS
to
YOU

1941 ADVERTISING CAMPAIGN BRINGS GOOD NEWS to DEALERS

*New Parker Schedule Promises to Create Even Greater
Demand for the Famous Parker Line*

With the second semester of the 1941 Parker Campaign about to break in leading newspapers, dealers everywhere look forward to an enthusiastic demand for Parker Pens, Pencils, Desk Sets and Quink throughout the coming months.

The ever-increasing success of these quality products in the face of economic uncertainty and restrictions more than justifies Parker's faith in continuing to advertise them widely to the public.

For extra profits in 1941 feature these dependable, fast-moving Parker products. Give the Parker a "place of honor" on your counter—where you can invite your customers to try its "smooth as oil" writing-ease.

On the following pages you will see forceful new advertisements featuring the Parker Vacumatic pen—the handsome, rich-looking gift sets—the new Parker Writefine Pencil—and Parker's easy-to-sell Quink. Remember—

ONLY **Parker** USES

THIS POWERFUL YEAR AROUND ADVERTISING

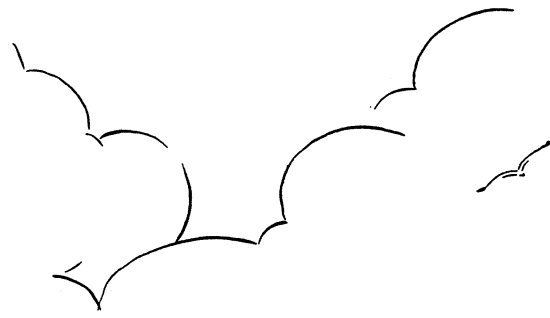

"Glides Easy
as a
Parker!"



"Right! And Parker's
FULL TELEVISION
ink supply never lets you
run out of 'fuel'!"



**YOU CAN'T AFFORD TO MISS
THE EXTRA INSPIRATION OF
PARKER'S Lubricated WRITING**



Parker
Vacumatic Pens
are Guaranteed
For Life by Parker's
BLUE DIAMOND

EFFORTLESS WRITING INSPIRES CLEAR THINKING... Your flow of ideas is definitely stimulated when you write with the pen that glides "smooth-as-oil." That is why the Parker Vacumatic actually *inspires* success. It's resilient, Osmidium tipped point can't wear scratchy.

GIVES ZEST FOR ANY WRITING TASK . . .

When a man dreads his writing jobs, chances are a poor pen is at the bottom of it. That is the time for him to experience the perfect balance and incredible writing ease of the new Parker Vacumatic. It takes the "work" out of writing.

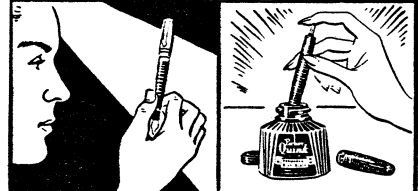

WON'T RUN DRY UNEXPECTEDLY— FILLS MORE EASILY... With the Vacumatic there is never that distracting uncertainty about when your pen may run dry. Parker's *Full Television* ink supply shows the ink level at all times. To refill, Parker's "One-hand" filler does it more *easily*, leaving nearly twice as much room for ink as old styles.

*Full
TELEVISION
Ink Supply*
shows ink
level at
all times

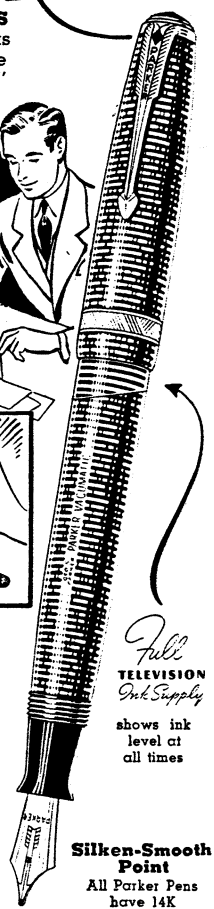

Parker
VACUMATIC
REGISTERED TRADEMARK

Silken-Smooth Point
All Parker Pens
have 14K
Gold Points
Osmidium Tipped

◆ Parker's Blue Diamond on the pen clip is our Life Contract with the owner Guaranteeing to make good any mishap (except loss or intentional damage) subject only to a small service charge to cover postage, insurance, and handling, provided complete pen is returned.

AVAILABLE AT ALL BETTER DEALERS

72-11

To Miss
 REATION OF
 WRITING

Parker
 Vacumatic Pens
 are Guaranteed
 For Life by Parker's
 BLUE DIAMOND

"Letter
 writing
 is EASY
 now!"

"Parker's lubricated
 point, tipped with
 costliest Osmiridium .
 fairly ZOOMS
 over the paper!"

Full
 TELEVISION
 Ink Supply
 shows ink
 level at
 all times

Silken-Smooth
 Point
 All Parker Pens
 have 14K
 Gold Points
 Osmiridium Tipped

Life Contract with the
 tap (except loss or inten-
 charge to cover postage,
 plete pen is returned.

DEALERS

72-11

2 col. x 11"

LET THIS INCREDIBLE VACUMATIC
 Guaranteed by Parker's Life Contract
 RELEASE YOU FOREVER FROM
 COMMON PEN TROUBLES



Parker
 Vacumatic Pens
 are Guaranteed
 For Life by Parker's
 BLUE DIAMOND

WON'T RUN DRY UNEXPECTEDLY . . .
 Some pens always seem to run out of ink
 just when you need them most. Parker's
 patented Full Television ink supply shows
 exactly how much ink you have in your
 pen at all times.

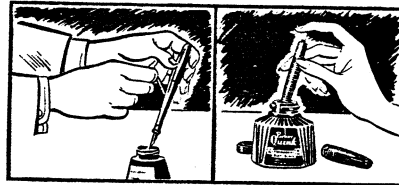

REVOLUTIONARY "ONE-HAND"
 FILLING CONVENIENCE . . . Whereas
 other pens with "levers" and "piston
 pumps" are awkward to fill even with two
 hands, Parker's patented "One-Hand"
 diaphragm filler operates with easy strokes of
 a single finger.



WON'T EVER WEAR SCRATCHY . . .
 You are now assured the extra-smooth-
 ness of Vacumatic's "lubricated" point
 forever. Parker's resilient, extra-fine
 grained 14K Gold Point—tipped with
 Osmiridium—is Guaranteed never to
 wear scratchy as long as you live.

Full
 TELEVISION
 Ink Supply

shows ink
 level at
 all times

Parker
 VACUMATIC
 REGISTERED TRADEMARK

Silken-Smooth
 Point
 All Parker Pens
 have 14K
 Gold Points
 Osmiridium Tipped

Parker's Blue Diamond on the pen clip is our Life Contract with the
 owner Guaranteeing to make good any mishap (except loss or inten-
 tional damage) subject only to a small service charge to cover postage,
 insurance, and handling, provided complete pen is returned.

AVAILABLE AT ALL BETTER DEALERS

72-12

Ad No. 72-12

2 col. x 11"

5

"That Patented
'One-Hand'
Filler is certainly
easy to operate!"



"But don't forget to
fill up with QUINK!
Keeps your Parker
'smooth-running'
ALL THE TIME!"



**QUINK...
AMAZING INK INVENTION
ACTUALLY CLEANS YOUR
PEN AS IT WRITES**

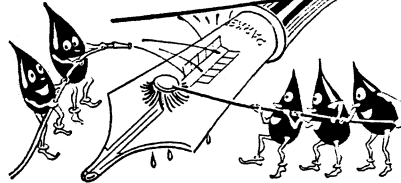

Parker
Vacumatic Pens
are Guaranteed
For Life by Parker's
BLUE DIAMOND

FIVE SECRET AGENTS GO TO WORK
as soon as you fill your pen with Quink. One dissolves sediment. The others clean your pen as it writes, retard evaporation, insure instant starting, and make Quink dry 31% faster.

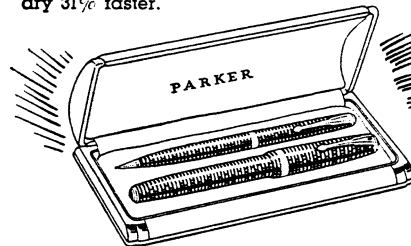

**CREATED TO GUARD THE PARKER
VACUMATIC...** Quink was first invented to protect the famous Vacumatic from inferior pen-clogging inks. But people soon discovered that, when filled with Parker Quink, any pen becomes a *self-cleaner*.

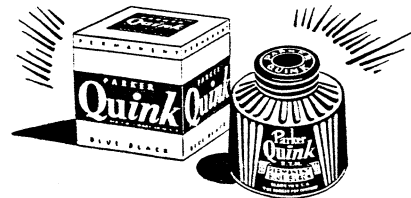

ALL PENS DESERVE QUINK. To avoid 69% of all pen troubles and banish annoying "ink-clog" forever, buy Quink today for every pen in your home and office. And to experience the supreme writing combination, try the new Parker Vacumatic... *plus Quink.*

Two Kinds:
Washable
and
Permanent

**Parker
Quink**

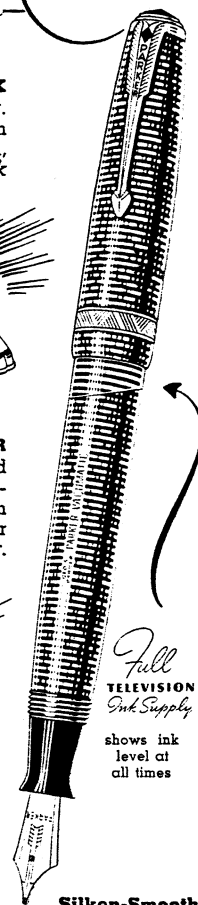

Full
TELEVISION
Ink Supply

shows ink
level at
all times

**Silken-Smooth
Point**
All Parker Pens
have 14K
Gold Points
Osmidium Tipped

◆ Parker's Blue Diamond on the pen clip is our Life Contract with the owner Guaranteeing to make good any mishap (except loss or intentional damage) subject only to a small service charge to cover postage, insurance, and handling, provided complete pen is returned.

AVAILABLE AT ALL BETTER DEALERS

72-13

**VENTION
NS YOUR
RITES**

**Parker
Vacumatic Pens
are Guaranteed
For Life by Parker's
BLUE DIAMOND**

"They say they build that
Parker Vacumatic with
Blue Diamond as carefully
as a high-powered motor!"

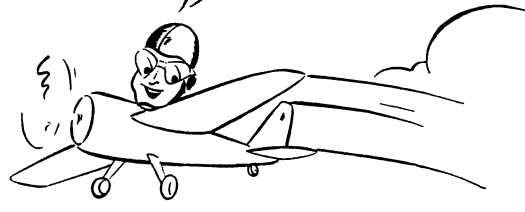

"Every Vacumatic passes 40
rigid tests! That's why Parker
gives a **GUARANTEE
FOR LIFE!**"

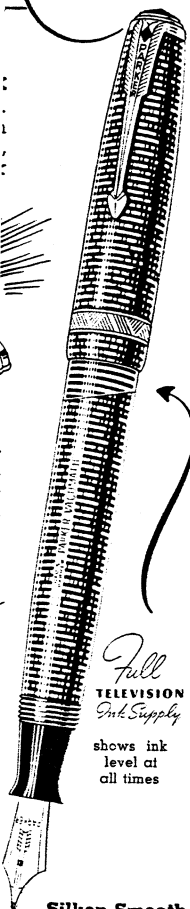
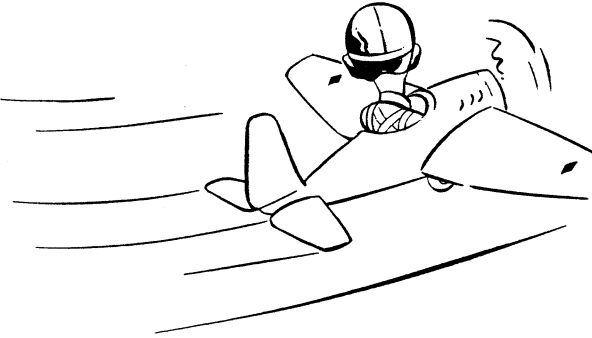

*Full
TELEVISION
Ink Supply*

shows ink
level at
all times

**Silken-Smooth
Point**
All Parker Pens
have 14K
Gold Points
Osmiridium Tipped

Life Contract with the
cap (except loss or inten-
tional damage) subject only to a small service charge to cover postage,
insurance, and handling, provided complete pen is returned.

DEALERS 72-13

2 col. x 11"

**HOW PARKER VACUMATIC'S
"LUBRICATED WRITING"
INSPIRES LIFELONG SUCCESS**



**Parker
Vacumatic Pens
are Guaranteed
For Life by Parker's
BLUE DIAMOND**

**THE POINT THAT CAN'T EVER WEAR
SCRATCHY . . .** Because it is tipped with
costliest Osmiridium, densest and hard-
est of all metals, the point of the Parker
Vacumatic is permanently "lubricated."
Year after year, it will glide smooth-as-oil,
giving you zest for every writing task.

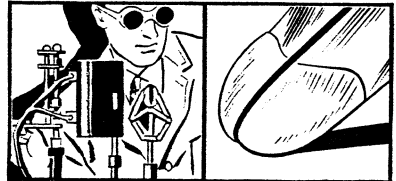

THE SECRET OF "LIVE" RESILIENCE . . .
In Parker laboratories the unfailing
Spectroscope scientifically selects only
flawless, extra-fine grained 14K Gold
for Vacumatic points. The instant you put
a Parker pen to paper you feel the live
responsiveness of its resilient point.

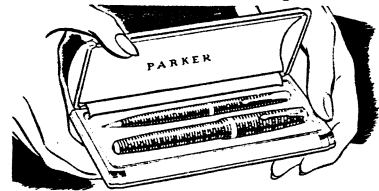

**VACUMATIC'S PERFECTION IS YOURS
FOREVER . . .** You benefit all through life
from the intrinsic quality and advanced
features built into the supreme Parker
Vacumatic pen. That is why a Parker
"Blue Diamond" Vacumatic actually
costs less to own than poorest pens.

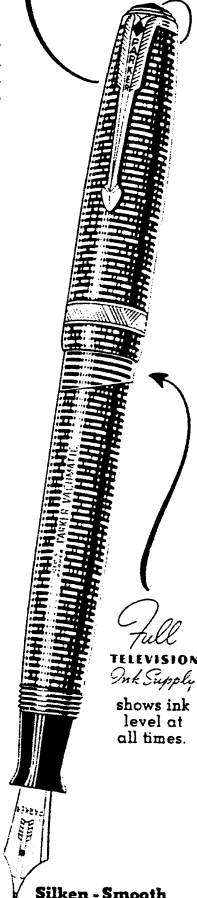

*Full
TELEVISION
Ink Supply*

shows ink
level at
all times.

**Silken - Smooth
Point**
ALL Parker Pens
have 14K
Gold Points
Osmiridium Tipped

Parker
VACUMATIC
Registered Trade Mark

Parker's Blue Diamond on the pen clip is our Life Contract with the
owner Guaranteeing to make good any mishap (except loss or inten-
tional damage) subject only to a small service charge to cover postage,
insurance, and handling, provided complete pen is returned.

AVAILABLE AT ALL BETTER DEALERS

72-14

Ad No. 72-14

2 col. x 11"

7

Someone in your family deserves this

**SUPREME
GIFT**



Parker
Vacumatic Pens
are Guaranteed For Life
by Parker's BLUE DIAMOND

**You can find no
finer Lifelong Token of your true
affection than the new Jewel-like**

PARKER VACUMATIC
GUARANTEED BY LIFE CONTRACT

FOR Father on his birthday, for Mother on her anniversary, for Son, Daughter or friend at graduation time . . . there never was a gift to equal the exciting combination of a stunning Parker Vacumatic pen and its matching Writefine pencil.

Never have pens offered such supreme writing satisfaction as do the jewel-like new Vacumatics marked by Parker's "Blue Diamond." Their incredibly resilient Points of extra-fine grained 14K Gold, tipped with

"oil-smooth" Osmiridium, give zest for any writing task. Their style of luminous laminated pearl is unique in pen-history. As also is Parker's Full Television ink supply, showing ink level at all times. And the sealed-in "One-Hand" filler, leaving twice as much room for ink as in old styles.

Best of all, Parker assures the owner of each "Blue Diamond" Vacumatic pen a lifetime of faultless service. Every laboratory-tested part, every advanced feature is Guaranteed by Life Contract. That is why it is so important to see that the pen you select bears Parker's "Blue Diamond" mark. Its promise of lifelong service is a sign of your true affection.

Full
TELEVISION
Ink Supply
shows ink
level at
all times.

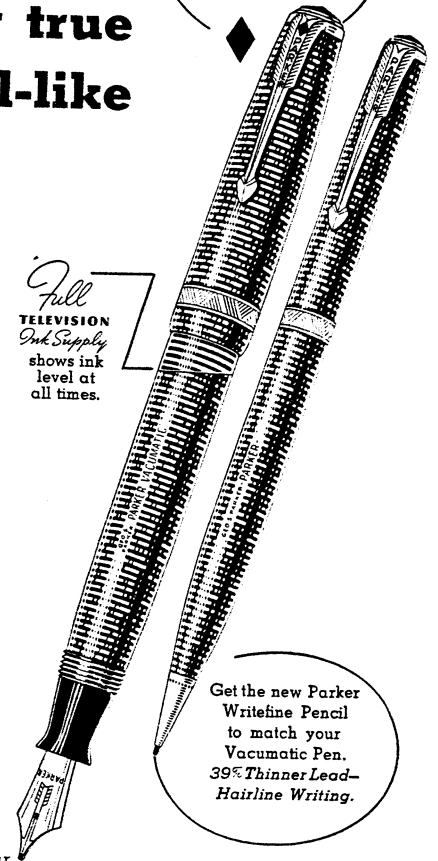

Get the new Parker
Writefine Pencil
to match your
Vacumatic Pen.
39% Thinner Lead-
Hairline Writing.

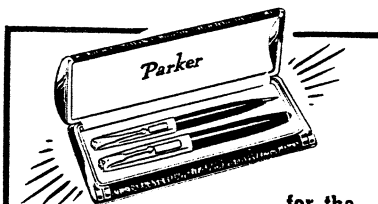

...for the
"ONE WHO MEANS MOST"

To a loved one for whom nothing is too good, give this superb personalized Gift Set. Its new Imperial Vacumatic Pen and Writefine Pencil are beautifully matched with monogrammed, gold-filled caps. The finest writing combination money can buy, packed in a stunning jewel case.

Parker
VACUMATIC
REGISTERED TRADEMARK

◆ Parker's Blue Diamond on the pen clip is our Life Contract with the owner Guaranteeing to make good any mishap (except loss or intentional damage) subject only to a small service charge to cover postage, insurance, and handling, provided complete pen is returned for service.

AVAILABLE AT ALL BETTER DEALERS

Ad No. 72-15

4 col. x 10"

72-15



"Can't think of
what to give
Mary!"

"Easy! A Parker
Vacumatic--she'll
think of you for LIFE!"





Parker Vacumatic Pens are Guaranteed For Life by Parker's BLUE DIAMOND

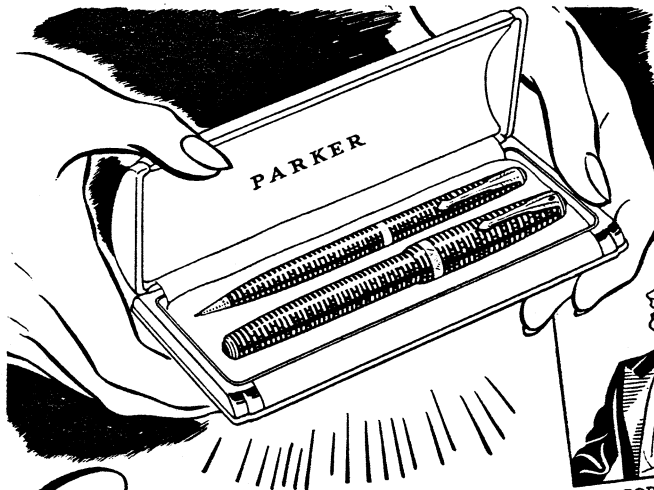

FOR GRADUATIONS



FOR BIRTHDAYS

FOR ANNIVERSARIES

Watch eyes light up...

when you give this dearly-cherished jewel-like PARKER VACUMATIC

The Gift that Delights Forever — because the pen is GUARANTEED BY LIFE CONTRACT

NO finer gift can be found than the handsome, jewel-like Parker Vacumatic pen. There's no better way to show your true affection—on a birthday, anniversary or for graduation—than to bestow this shimmering beauty which is Guaranteed by Life Contract to render supreme service to its owner. Critical student leaders in 136 colleges recently voted Parker Vacumatic the first choice gift by nearly 3 to 1! The reason is that Parker is the only pen of its kind in the world.

There's no other style like Vacumatic's luminous, laminated pearl barrel with Full Television ink supply. No other fil-

ler so EASY and convenient as Parker's "One-Hand" filler, with its Diaphragm sealed in the top—leaving nearly twice as much room for ink as old-styles. No other pen point equals Parker's super-resilient, extra fine-grained 14K Gold—tipped with costliest Osmiridium to write forever as "smooth as oil." Ask any nearby Parker dealer to show you his stunning new Gift Sets of Vacumatic Pens with matching Writefine Pencils. And be sure to watch for Parker's "Blue Diamond" on the smart Arrow Clip. It identifies the pen that will be cherished forever, because it is GUARANTEED BY LIFE CONTRACT.

Parker Vacumatic Pens are Guaranteed For Life by Parker's BLUE DIAMOND.

Full Television Ink Supply

shows ink level at all times

Get the new Parker Writefine Pencil to match your Vacumatic Pen. 39% Thinner Lead Hairline Writing.

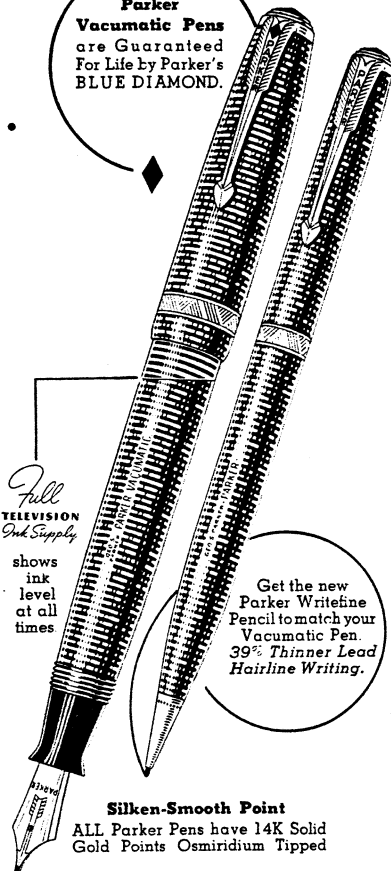

Silken-Smooth Point

ALL Parker Pens have 14K Solid Gold Points Osmiridium Tipped

AVAILABLE AT ALL BETTER DEALERS

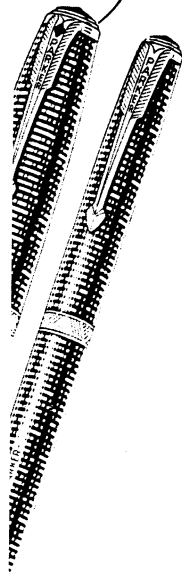

the new Parker Writefine Pencil match your Vacumatic Pen. Thinner Lead—Hairline Writing.

BETTER DEALERS

4 col. x 10"

◆ Parker's Blue Diamond on the pen clip is our Life Contract with the owner Guaranteeing to make good any mishap (except loss or intentional damage) subject only to a small service charge to cover postage, insurance, and handling, provided complete pen is returned for service.

Parker VACUMATIC REGISTERED TRADEMARK 72-16

Ad No. 72-16

4 col. x 10"

"And best of all—Parker Vacumatic with Blue Diamond actually costs LESS TO OWN than the poorest pen!"

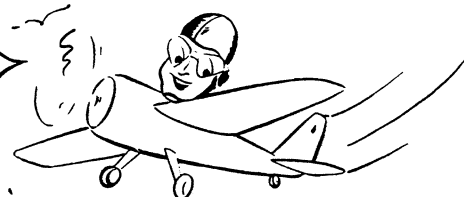
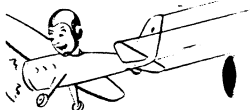



PARKER

Advertisements

Build up Gift Sales

EVERY DAY in the YEAR

Bring Extra Profits, Quicker Turnover

If you wait until Christmas to feature gifts, you are missing countless opportunities that occur throughout each month of the year—

- BIRTHDAYS
- FESTIVALS
- ANNIVERSARIES
- CONVALESCENCE
- GRADUATIONS

Parker advertising—unlike that of any other pen manufacturer—is scheduled on a month in and month out basis, so that you may profit to the utmost by these many important gift occasions. See the impressive gift advertisements on Pages 8 and 9. These attractive newspaper ads are making Parker Pens, Pencils and matching Sets the most “talked about” gifts in your community. They are suitable equally for social and business gifts, for young as well as old.

Check the schedule on the opposite page—for the dates on which these advertisements will appear in your territory.

PARKER ADVERTISING SCHEDULE

. . .

SECOND SEMESTER 1941



R
nts
les
AR

over

less op-

manufac-
basis, so
mportant
on Pages
g Parker
ut" gifts
ocial and

dates on
ory.

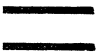

For New Ease
in Writing-



Parker
VACUMATIC

WITH BLUE DIAMOND

This beautiful pen is guaranteed to give a lifetime of writing pleasure! Come in today and ask for a Parker Vacumatic with Blue Diamond Guaranteed for Life

Your Name Here

Dealer Ad No. 7208
1 col. x 4"

... forever
YOURS

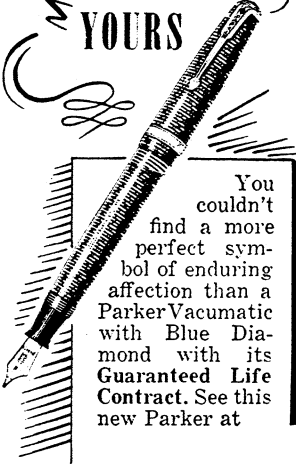

You couldn't find a more perfect symbol of enduring affection than a Parker Vacumatic with Blue Diamond with its Guaranteed Life Contract. See this new Parker at

Your Name Here

Dealer Ad No. 7209
1 col. x 4"



Make
Writing
a **NEW DELIGHT!**

If letter writing is a task, try this new Parker Vacumatic with Blue Diamond! Its silken-smooth point will give you a writing thrill! You will admire its jewel-like design. See our selection of Parker Pens with Guaranteed Life Contract, and beautiful new Gift Sets.



Parker
with Blue Diamond

Your Name Here

Dealer Ad No. 7210

2 col. x 3"

Use These Striking Small Space Ads . . . to Direct Customers to Your Establishment

To take full advantage of each of the large sized Parker advertisements that will be appearing in your locality, run one of these inexpensive small space ads **OVER YOUR OWN NAME** in the same issue. The space cost is small—but the prominent attention that these well-planned ads obtain brings you profitable returns.

We can furnish either electros or mats. They are **FREE**. Simply order by number.

It Cleans Your Pen As It Writes

Parker Quink, the modern ink, dissolves deposits left by pen-clogging inks. Makes all pens write better. Two kinds of Quink: Permanent and Washable. 2 oz. 15c, 4 oz. 25c.



Parker Quink

Your Name Here

Dealer Ad No. 7207

2 col. x 2"

Direct Your Messages to Local Cinema Audiences

An important center of social life in your community, your neighborhood cinema offers a unique opportunity to bring YOUR MESSAGE prominently before LARGE AUDIENCES. These handsome, expertly made Parker slides, when they appear on the screen, call instant attention to your establishment as headquarters for Parker Pens and Gift Sets.

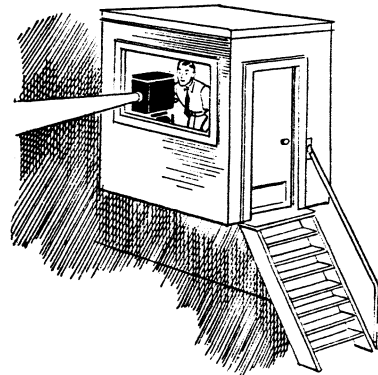

These cinema slides are supplied FREE. Order from us by number.

Don't forget to write!

Don't Forget His Parker and He Won't Forget You!

Your Name Here

Cinema Slide No. 700

GIVE YOUR PEN NEW LIFE

with Parker Quink

THE INK THAT CLEANS ANY PEN AS IT WRITES

A Secret Ingredient dissolves sediment left in Pens by other inks.

Your Name Here

Cinema Slide No. 701

Now you can afford THE FINEST PEN IN THE WORLD

The Supreme New Parker VACU-MATIC with Blue Diamond

COSTS LESS TO OWN THAN THE POOREST PENS - BECAUSE IT'S GUARANTEED FOR LIFE!

Your Name Here

Cinema Slide No. 702

FOR A NEW THRILL IN Writing TRY THE REVOLUTIONARY

Parker VACU-MATIC WITH BLUE DIAMOND

Full TELEVISION INK SUPPLY

GUARANTEED FOR LIFE

Your Name Here

Cinema Slide No. 703



Parker
Blue Diamond

1. x 3"

ent
r ad-
ne of
IE in
it at-
table

mply

Writes
by pen-clog-
s of Quink:
ic.

er
nk

x 2"



Is the **NAME OF YOUR ESTABLISHMENT** heard over the Air? ...

IT CAN BE . . . And at very little cost by using these ½ minute spot announcements. Try them . . . for quick results

RADIO SPOTS

1 Seeing is believing!—so drop in at (Name of Dealer) by all means—and SEE that incredible Parker Vacumatic Pen with **Blue Diamond**! You will be delighted with its rich-looking, laminated pearl design—the exquisite EASE with which it glides on paper! And don't forget, this jewel-like pen has a **GUARANTEE FOR LIFE!**

3 Put down (Name of Dealer) on your shopping list—because you'll want to see their exquisite assortment of Parker Vacumatic Pens with **Blue Diamond** without delay. Styled by a famous designer, the sheer beauty of this pen is matched only by its superb performance—its incredible EASE in writing! See it here tomorrow!

5 When it comes to that extra special gift, come to (Name of Dealer) . . . Ask to see their beautiful Parker Vacumatic Pen with **Blue Diamond**—the pen with the **GUARANTEED LIFE CONTRACT**. Write with it! —notice how it glides as smooth as oil! Jewel-like in every detail, it makes a particularly desirable gift!

2 Stop hunting for that "Perfect Gift"! Instead, drop in at (Name of Dealer) and see their magnificent selection of Parker Vacumatic Pens with **Blue Diamond**—smart, lustrous, with laminated pearl design! Because this pen has a **GUARANTEED LIFE CONTRACT**, it is indeed the perfect gift that will be cherished FOREVER.

4 Annoyed by "pen troubles"? Then come to (Name of Dealer) and try a Parker Vacumatic with **Blue Diamond**. Know what a thrill writing can be! And remember—with Parker's **GUARANTEED LIFE CONTRACT** this jewel of a pen will never wear scratchy—as long as you live! See our assortment of Parker Pens tomorrow!

6 Do you want to own the world's finest pen? Then drop in at (Name of Dealer) and see the Parker Vacumatic with **Blue Diamond**. No other pen offers such supreme writing ease—such dazzling beauty of design! Best of all this incredible pen carries a **GUARANTEED LIFE CONTRACT**. See them without delay!

NEW PARKER WINDOW DISPLAYS

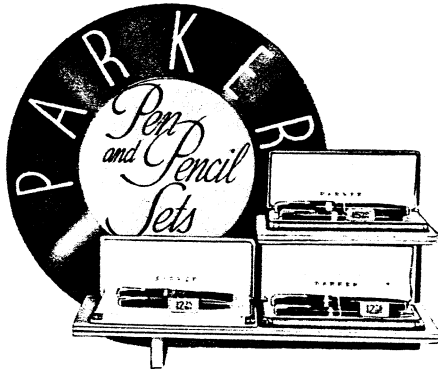

CIRCLE DISPLAY NO. 488
13" high, 14" wide, 4" deep
Weight: Net 2 lbs., Gross 4 lbs.

This compact yet extremely striking display piece fits into any window arrangement or on the pen counter. The disc is made of highly polished white glass with contrasting rich blue.

Price—\$1.00 net.

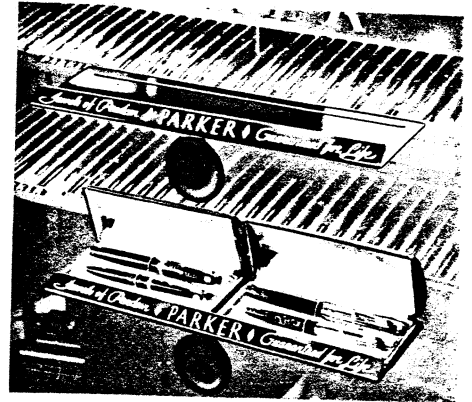

SPOT SHELF NO. 460
12" long, 3" deep. Net weight 8 oz.

Made of polished bronze. Shelf with small suction cup which can be attached to inside of showcase or against window. Holds two gift boxes.

Free with Vacumatic Set orders.

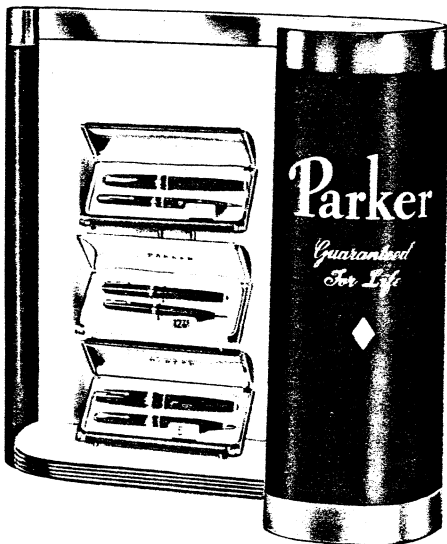

SCROLL DISPLAY NO. 485
17" high, 18" wide, 6" deep
Weight: Net 5 lbs., Gross 8 lbs.

In this new Parker display, a combination of wood and acetate has been worked into a scroll design. Polished brass bands at top and bottom form a most attractive frame for three Parker Pen and Pencil Sets, which are bathed in a soft glowing light emanating from the 15" fluorescent tube enclosed in the scroll.

Price—\$3.00 net.

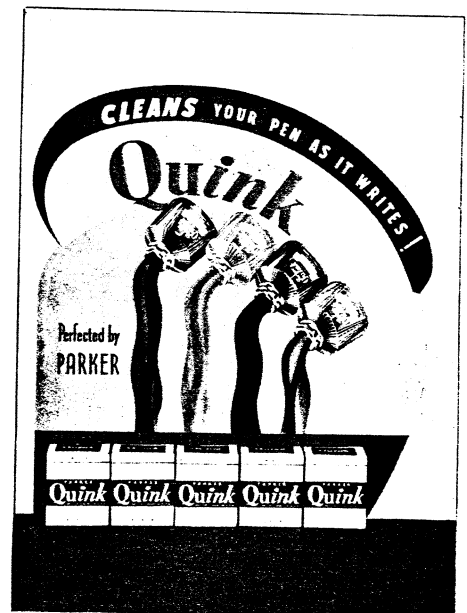

QUINK FLASHER NO. 394-E
16½" high, 15" wide
Weight: Net 8 oz., Gross 2 lbs.

Made of cardboard. Lithographed in 7 colors. Fitted with six foot electric wire. State electric current.

Free with Quink orders.

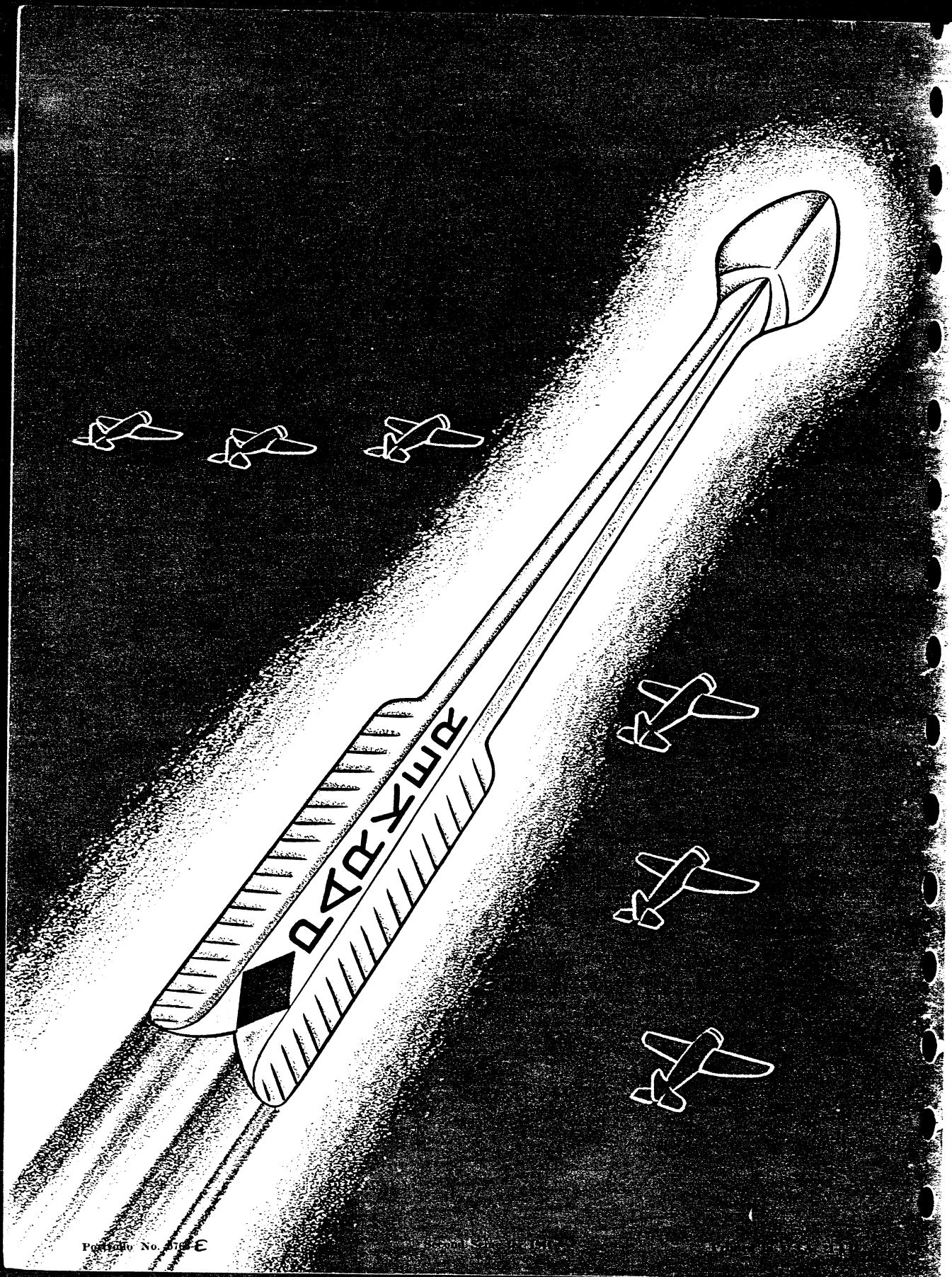

Propaganda No. 112-E